

WIRING DIAGRAMS FOR BUDGIT & SHAW-BOX SINGLE GIRDER CRANE BRIDGE KITS (FOR 113533-71, 113535-2, 113535-6 AND 113533-75)

ELEMENTARY DIAGRAM

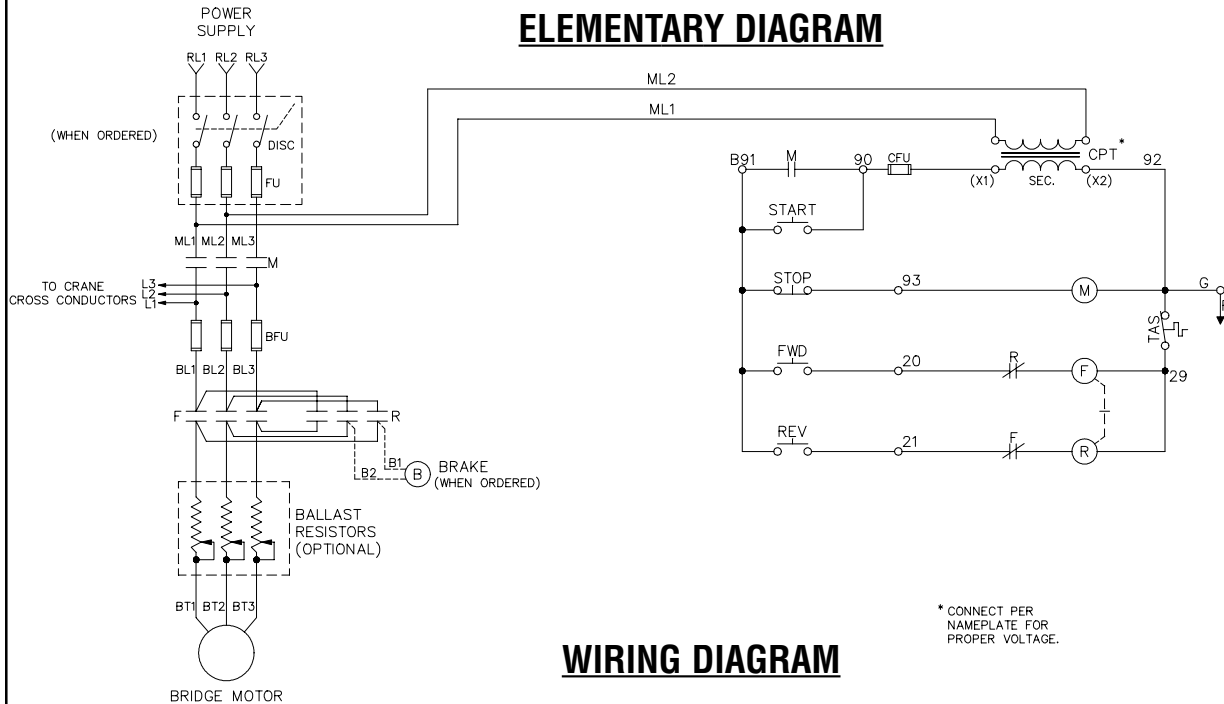

WIRING DIAGRAM

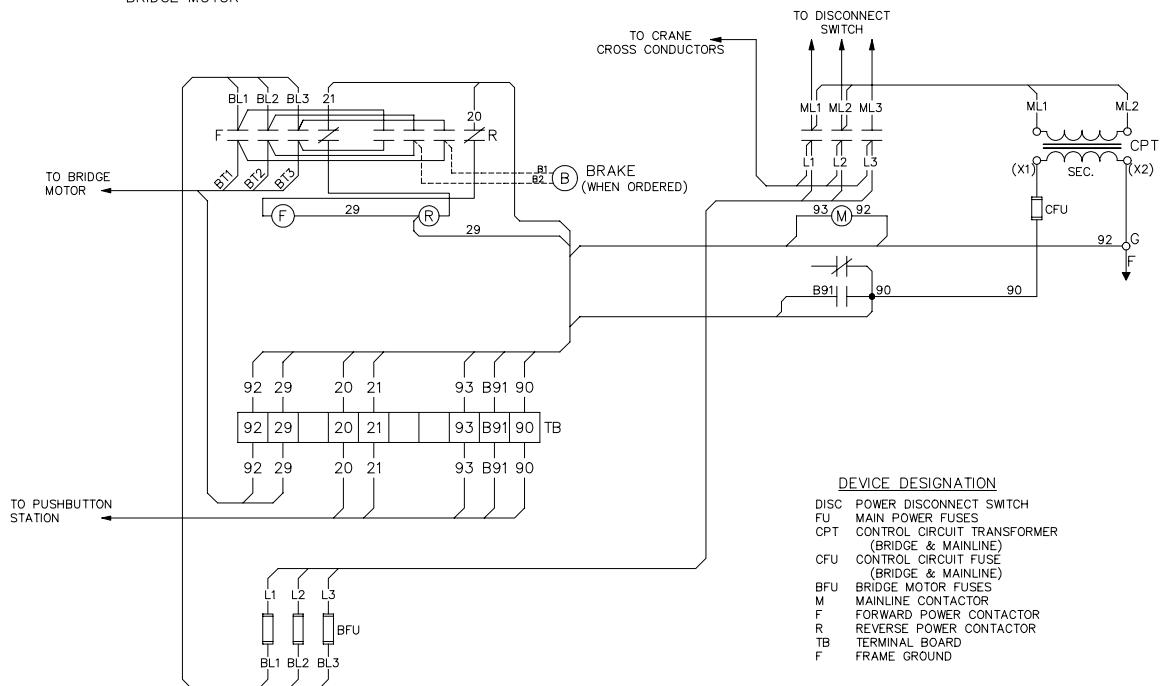

* CONNECT PER NAMEPLATE FOR PROPER VOLTAGE.

- DEVICE DESIGNATION**
- DISC POWER DISCONNECT SWITCH
 - FU MAIN POWER FUSES
 - CPT CONTROL CIRCUIT TRANSFORMER (BRIDGE & MAINLINE)
 - CFU CONTROL CIRCUIT FUSE (BRIDGE & MAINLINE)
 - BFU BRIDGE MOTOR FUSES
 - M MAINLINE CONTACTOR
 - F FORWARD POWER CONTACTOR
 - R REVERSE POWER CONTACTOR
 - TB TERMINAL BOARD
 - F FRAME GROUND

WARNING
THIS EQUIPMENT MUST BE EFFECTIVELY GROUNDED ACCORDING TO APPLICABLE CODES.

AVERTISSEMENT
CET EQUIPEMENT DOIT ETRE MIS A'LA TERRE EN ACCORDANCE AVEC LES NORMES EN VIGUEUR.

SINGLE SPEED

329153 SHT. 1 REV. 6

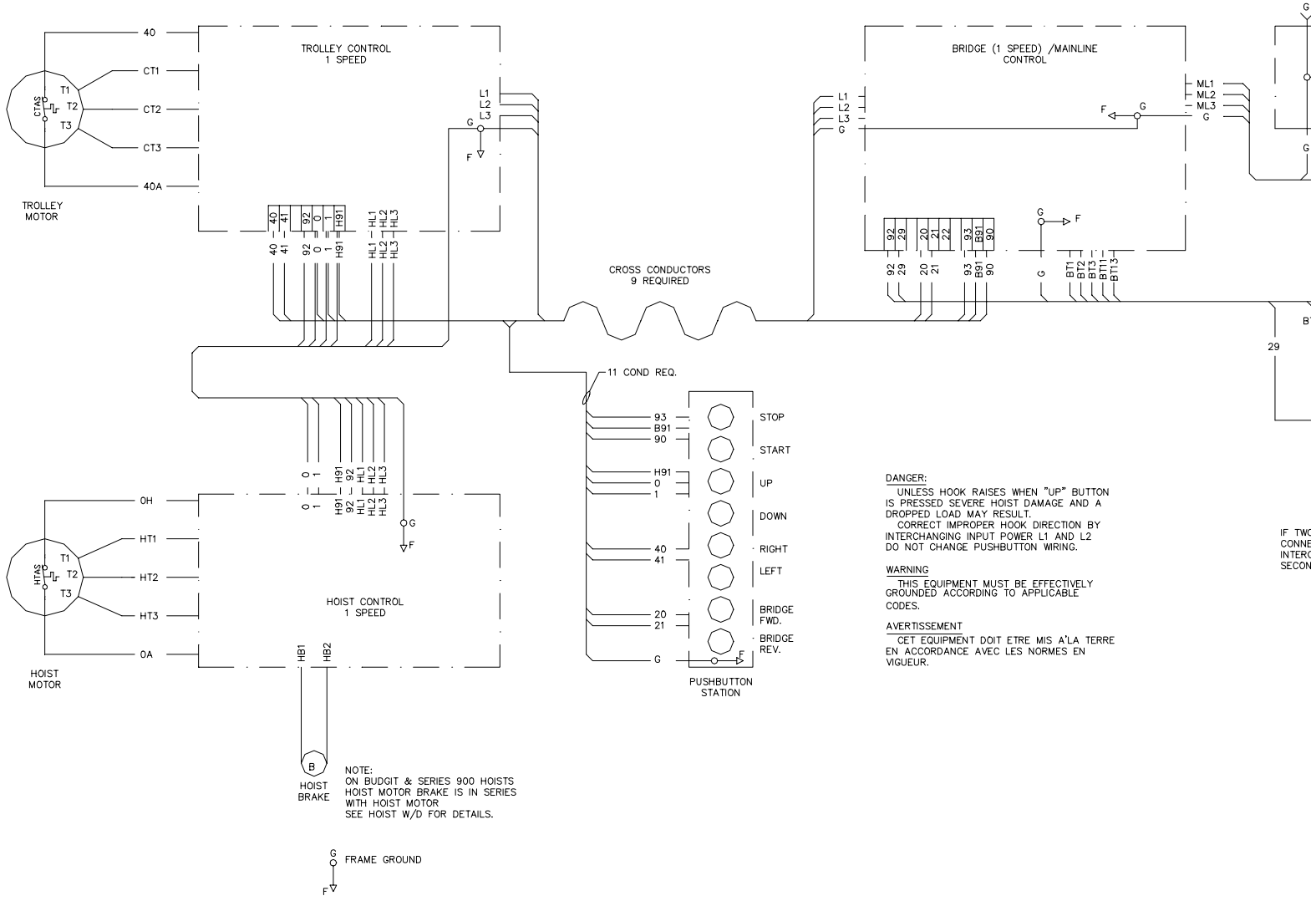

DANGER:
 UNLESS HOOK RAISES WHEN "UP" BUTTON IS PRESSED SEVERE HOIST DAMAGE AND A DROPPED LOAD MAY RESULT.
 CORRECT IMPROPER HOOK DIRECTION BY INTERCHANGING INPUT POWER L1 AND L2 DO NOT CHANGE PUSHBUTTON WIRING.

WARNING
 THIS EQUIPMENT MUST BE EFFECTIVELY GROUNDED ACCORDING TO APPLICABLE CODES.

AVERTISSEMENT
 CET EQUIPEMENT DOIT ETRE MIS A LA TERRE EN ACCORDANCE AVEC LES NORMES EN VIGUEUR.

IF TWC CONNE INTERC SECON

NOTE:
 ON BUDGIT & SERIES 900 HOISTS HOIST MOTOR BRAKE IS IN SERIES WITH HOIST MOTOR SEE HOIST W/D FOR DETAILS.

FRAME GROUND

INTERCONNECTION DIAGRAM 1 SPEED HOIST, 1 SPEED TROLLEY, 1 SPEED BRIDGE PUSHBUTTON FROM TROLLEY

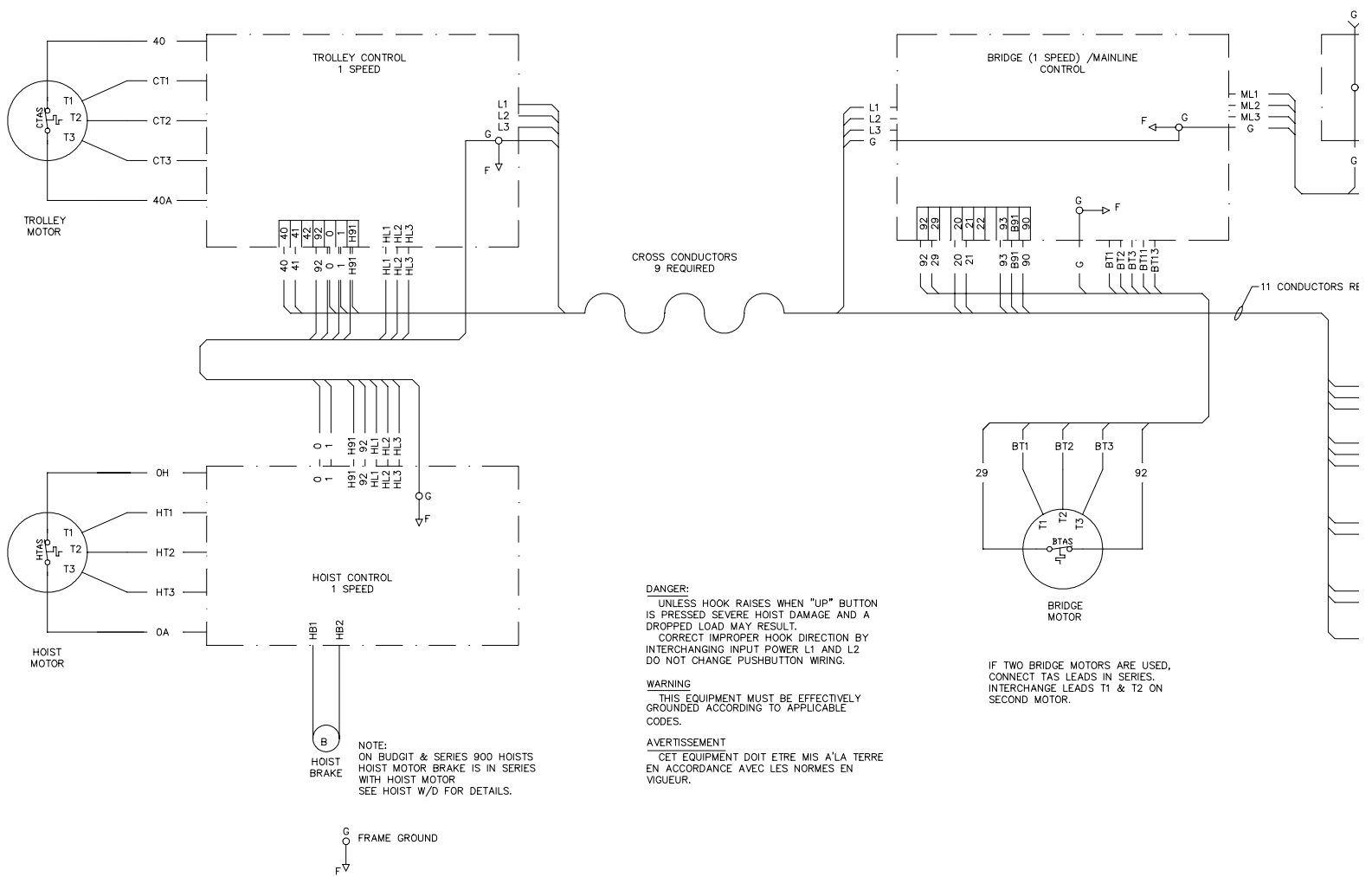

DANGER:
 UNLESS HOOK RAISES WHEN "UP" BUTTON IS PRESSED SEVERE HOIST DAMAGE AND A DROPPED LOAD MAY RESULT. CORRECT IMPROPER HOOK DIRECTION BY INTERCHANGING INPUT POWER L1 AND L2 DO NOT CHANGE PUSHBUTTON WIRING.

WARNING
 THIS EQUIPMENT MUST BE EFFECTIVELY GROUNDED ACCORDING TO APPLICABLE CODES.

AVERTISSEMENT
 CET EQUIPEMENT DOIT ETRE MIS A'LA TERRE EN ACCORDANCE AVEC LES NORMES EN VIGUEUR.

NOTE:
 ON BUDGIT & SERIES 900 HOISTS HOIST MOTOR BRAKE IS IN SERIES WITH HOIST MOTOR SEE HOIST W/D FOR DETAILS.

IF TWO BRIDGE MOTORS ARE USED, CONNECT T1S LEADS IN SERIES. INTERCHANGE LEADS T1 & T2 ON SECOND MOTOR.

**INTERCONNECTION DIAGRAM
 1 SPEED HOIST, 1 SPEED TROLLEY, 1 SPEED BRIDGE
 PUSHBUTTON FROM BRIDGE**

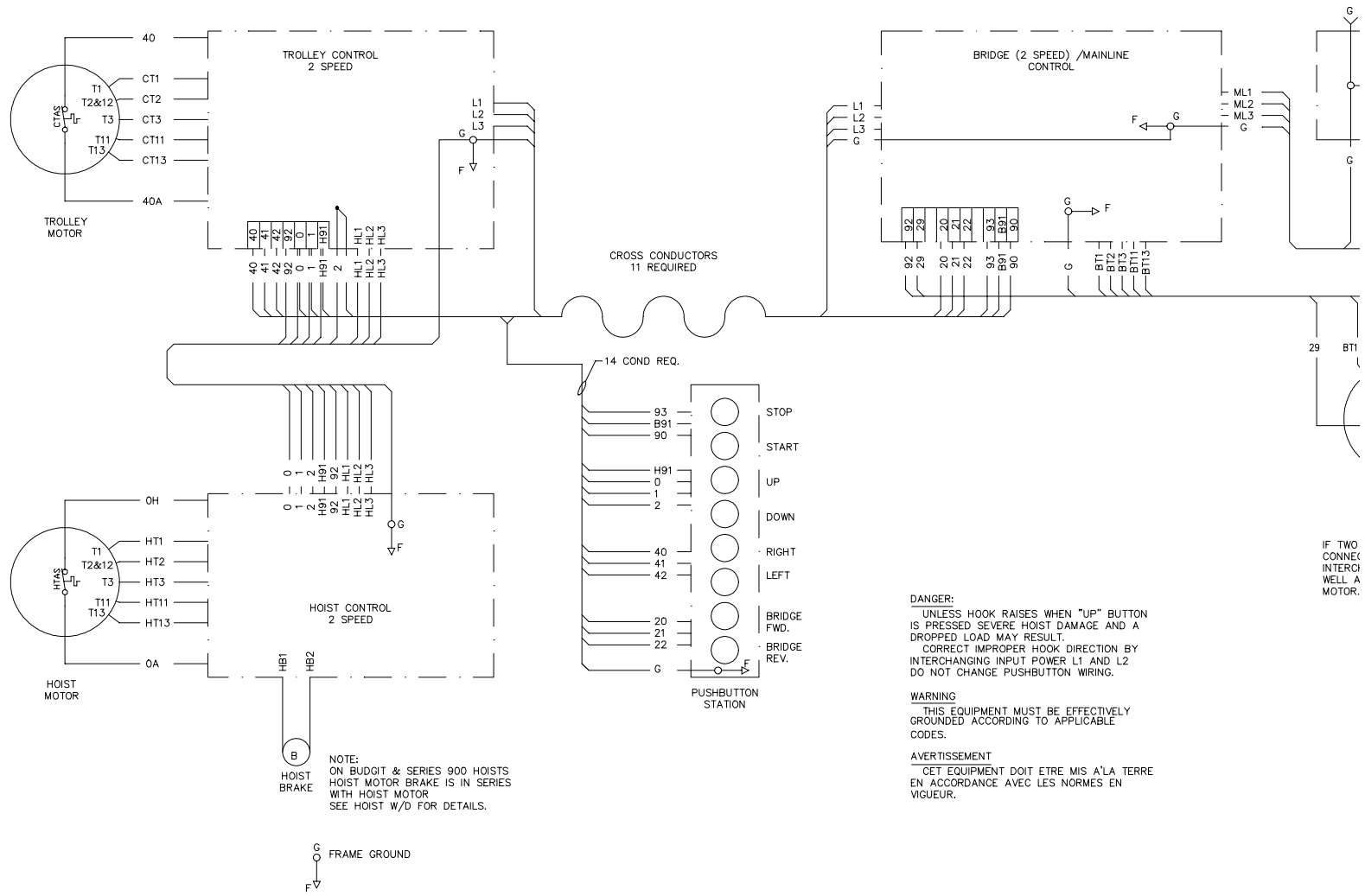

**INTERCONNECTION DIAGRAM
2 SPEED HOIST, 2 SPEED TROLLEY, 2 SPEED BRIDGE
PUSHBUTTON FROM TROLLEY**

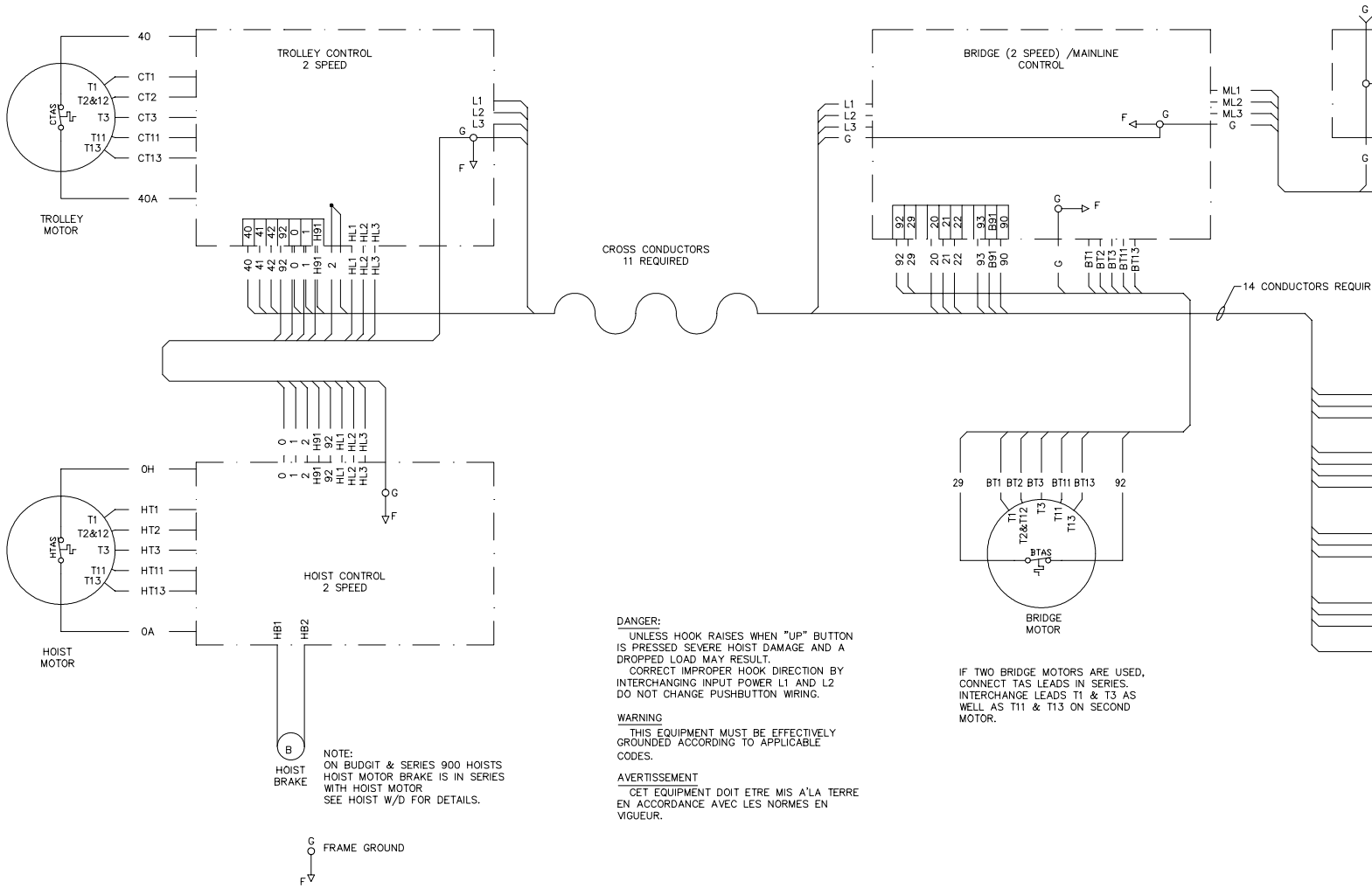

**INTERCONNECTION DIAGRAM
2 SPEED HOIST, 2 SPEED TROLLEY, 2 SPEED BRIDGE
PUSHBUTTON FROM BRIDGE**

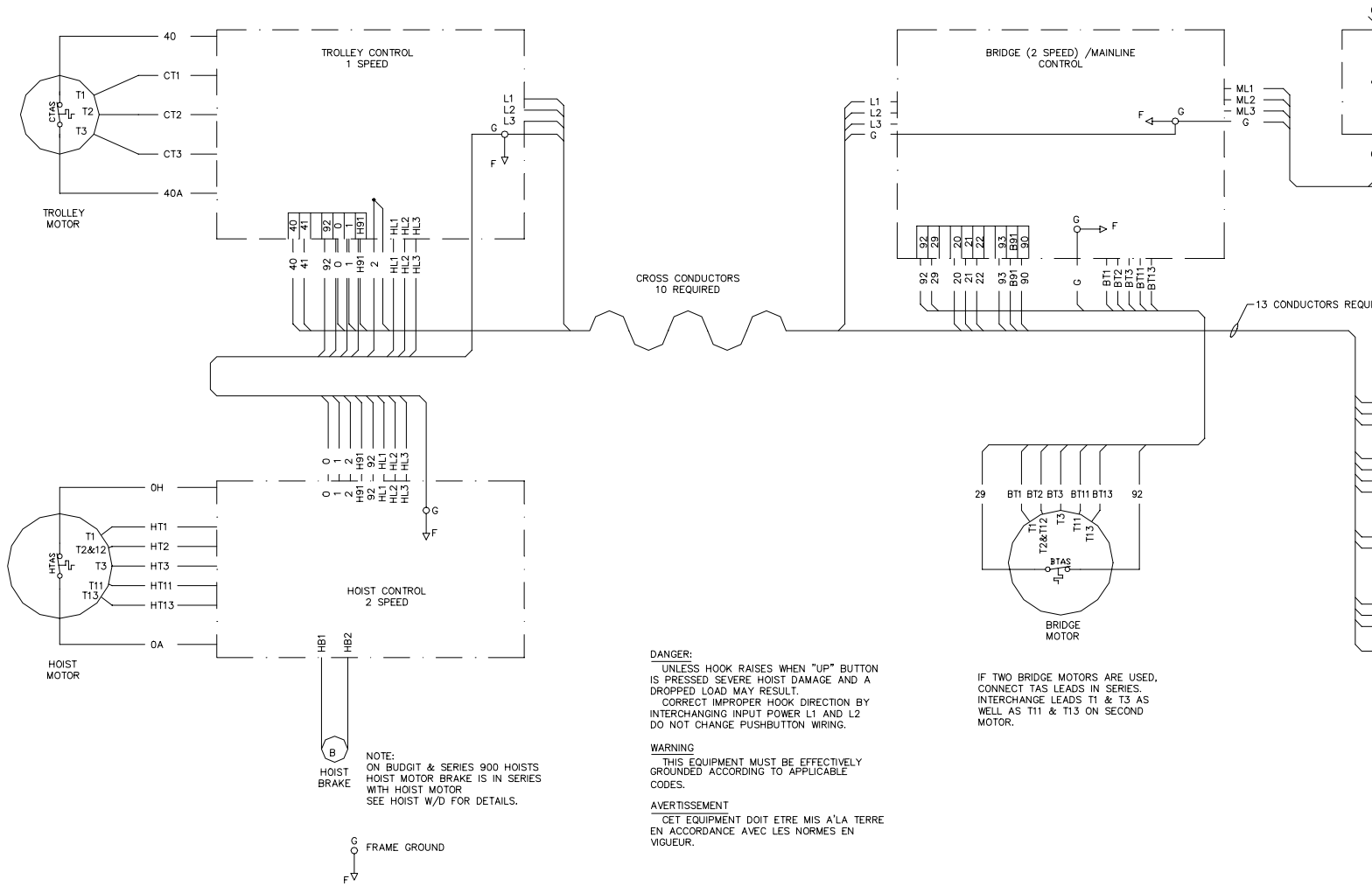

DANGER:
 UNLESS HOOK RAISES WHEN "UP" BUTTON IS PRESSED SEVERE HOIST DAMAGE AND A DROPPED LOAD MAY RESULT.
 CORRECT IMPROPER HOOK DIRECTION BY INTERCHANGING INPUT POWER L1 AND L2 DO NOT CHANGE PUSHBUTTON WIRING.

WARNING
 THIS EQUIPMENT MUST BE EFFECTIVELY GROUNDED ACCORDING TO APPLICABLE CODES.

AVERTISSEMENT
 CET EQUIPEMENT DOIT ETRE MIS A LA TERRE EN ACCORDANCE AVEC LES NORMES EN VIGUEUR.

IF TWO BRIDGE MOTORS ARE USED, CONNECT T&S LEADS IN SERIES. INTERCHANGE LEADS T1 & T3 AS WELL AS T11 & T13 ON SECOND MOTOR.

NOTE:
 ON BUDGET & SERIES 900 HOISTS HOIST MOTOR BRAKE IS IN SERIES WITH HOIST MOTOR SEE HOIST W/D FOR DETAILS.

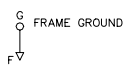

**INTERCONNECTION DIAGRAM
 2 SPEED HOIST, 1 SPEED TROLLEY, 2 SPEED BRIDGE
 PUSHBUTTON FROM BRIDGE**

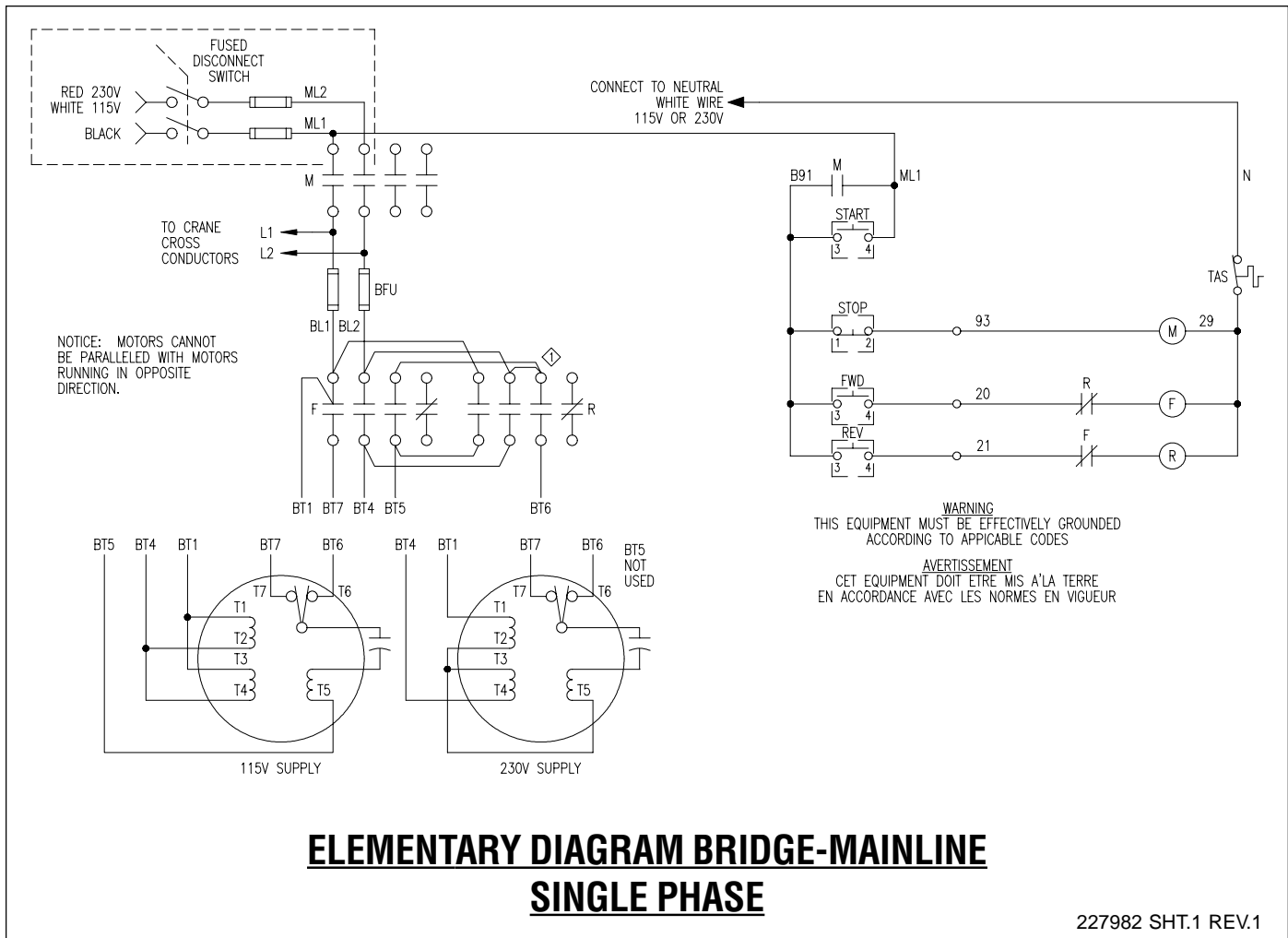

WARRANTY

WARRANTY AND LIMITATION OF REMEDY AND LIABILITY

A. Seller warrants that its products and parts, when shipped, and its work (including installation, construction and start-up), when performed, will meet applicable specifications, will be of good quality and will be free from defects in material and workmanship. All claims for defective products or parts under this warranty must be made in writing immediately upon discovery and, in any event, within one (1) year from shipment of the applicable item unless Seller specifically assumes installation, construction or start-up responsibility. All claims for defective products or parts when Seller specifically assumes installation, construction or start-up responsibility, and all claims for defective work must be made in writing immediately upon discovery and, in any event, within one (1) year from completion of the applicable work by Seller, provided; however, all claims for defective products and parts must be made in writing no later than eighteen (18) months after shipment. Defective items must be held for Seller's inspection and returned to the original f.o.b. point upon request. THE FOREGOING IS EXPRESSLY IN LIEU OF ALL OTHER WARRANTIES WHATSOEVER, EXPRESS, IMPLIED AND STATUTORY, INCLUDING, WITHOUT LIMITATION, THE IMPLIED WARRANTIES OF MERCHANTABILITY AND FITNESS.

B. Upon Buyer's submission of a claim as provided above and its substantiation, Seller shall at its option either (i) repair or replace its product, part or work at either the original f.o.b. point of delivery or at Seller's authorized service station nearest Buyer or (ii) refund an equitable portion of the purchase price.

C. This warranty is contingent upon Buyer's proper maintenance and care of Seller's products, and does not extend to Normal wear and tear. Seller reserves the right to void warranty in event of Buyer's use of inappropriate materials in the course of repair or maintenance, or if Seller's products have been dismantled prior to submission to Seller for warranty inspection.

D. The foregoing is Seller's only obligation and Buyer's exclusive remedy for breach of warranty, and is Buyer's exclusive remedy hereunder by way of breach of contract, tort, strict liability or otherwise. In no event shall Buyer be entitled to or Seller liable for incidental or consequential damages. Any action for breach of this agreement must be commenced within one (1) year after the cause of action has accrued.